

CENTRE WASTE BALCONY BASE

INSTALLATION GUIDE



IMPORTANT INFO

THIS GUIDE

This document is a guide only and does not cover all unforeseen onsite circumstances. The information within this guide is designed to assist with installation of the systems. A tradesman, builder or DIY'er must draw on trade skill/knowledge to overcome onsite challenges that are not covered within this document as not all variants of site preparation can be predicted or covered.

THE SYSTEM

ISB (Insitu Shower Base) and IPS (Insitu Panelling System) are a fully customizable precision made panelling systems designed to eliminate the use of sand and cement screeds. The weight reduction is of great benefit in relation to overcoming structural engineering challenges and compliment light weight construction. All ISB and IPS panels are constructed of a light weight water resistant formulation and are CNC machined to millimetre perfect dimensions including fall ratios that meet and often far exceed Australian Standard requirements. The panels are able to be manufactured in a range of profile thicknesses and are available in an advanced 'click' system to cover large areas. Demtech offer these technologically advance panelling systems in a variety of 'centre/off-centre' and linear grate style finishes. A factory protective coat of Cureflex SLR2000 is applied to each panel before dispatch (this does not form any part of the required waterproofing system to be applied after panel installation is complete). The ISB and IPS dramatically reduce onsite down time as they are fully cured in an average 48 hours (temperature dependant). Both Demtech ISB and IPS can be installed and waterproofed in the same day and allowed to cure as a complete system (application dependant).

All ISB, IPS and WP systems are tried and tested and are BRANZ approved including all Insitu, Cureflex and Nero product ranges. Nero products are all WaterMarked and meet Australian standard requirements.

RECOMMENDATIONS

All ISB and IPS systems both internal and external require a full liquid membrane system applied over them once installed and cured. These waterproofing systems must meet the Australian Standards 'AS3740 for internal and AS4654 for external. Waterproofing systems applied over the ISB and IPS systems should utilize water based acrylic products. The Demtech ISB and IPS system is not a waterproof system in its self but can be made water tight through correct and thorough installation processes. Products that are tried and tested and have attained a full BRANZ approval for waterproofing application over ISB and IPS systems can be found in our Cureflex and Trims 'n' Finishes range. It is the responsibility of the builder, tradesman or user to ensure that all substrates and structures constructed/installed prior to installation of the Demtech ISB and IPS systems are compliant with the Australian Standards requirement, building codes and are constructed/installed in accordance to all manufacturers' recommendations. ISB and IPS are not 'self-supporting' (non-structural) and require standard flooring structures both internally and externally that comply with all building codes, Australian Standards and manufacturer's recommendations.

WARRANTY

The products supplied in the Demtech ISB and IPS systems as well as materials are covered under a factory product warranty. That is that the products themselves are supplied without manufacturing fault from factory. Workmanship including installation and modification of the Demtech ISB and IPS systems is not covered by Demtech as a manufacturer of the products. This warranty responsibility and obligation is held by the party completing the installation and or modification of the systems supplied. Demtech take no responsibility for workmanship or installation of these systems completed by third party persons.

For further information on our products, systems and services visit our website at www.demtech.com.au

WHAT'S REQUIRED

01. Insitu™ Balcony Panels
02. Nero™ Leak Control Flange (LCF)
03. Nero™ Sleeve & Grommet OR Nero™ Sleeve Extension & Grommet
04. Protective Matting
05. PVC Flashing
06. Barrier Tape
07. Cureflex™ HV124 Silane
08. Cureflex™ PG57 Primer
09. Cureflex™ TX88 Tile Adhesive
10. Warning Sign
11. 133mm Hole Saw
11. 5.5mm Drill Bit
11. Arbour Drill Bit
12. 25mm Wood Screws
12. 75mm Wood Screws
12. 75mm Hex Drive Screws
01. Caulking Gun
02. Cordless Drill
03. Dustpan & Brush
04. 600/900/1200mm Level
05. Mixing Drill/Attachment
06. Paint Roller (230mm max.)
07. Paint Brush (100mm max.)
08. PH2 Driver Drill Bit
09. Pencil/Marker
10. Small Handsaw
11. Spatula
12. Tinsnips
13. Utility Knife
14. 12mm Notched Trowel
15. 5.5mm Hex Drive Drill Bit
16. Hammer
17. Chisel

WHAT'S REQUIRED



INSTALLATION STEPS

01.

Check to ensure that the substrate, structure and set down comply with regulations and has been installed as per the manufacturer's recommendations.

Also check that the area is level before commencing any works (**3mm max.** height variation across **2m** distances).

DO NOT PROCEED IF THE SUBSTRATE DOES NOT MEET THESE CONDITIONS.

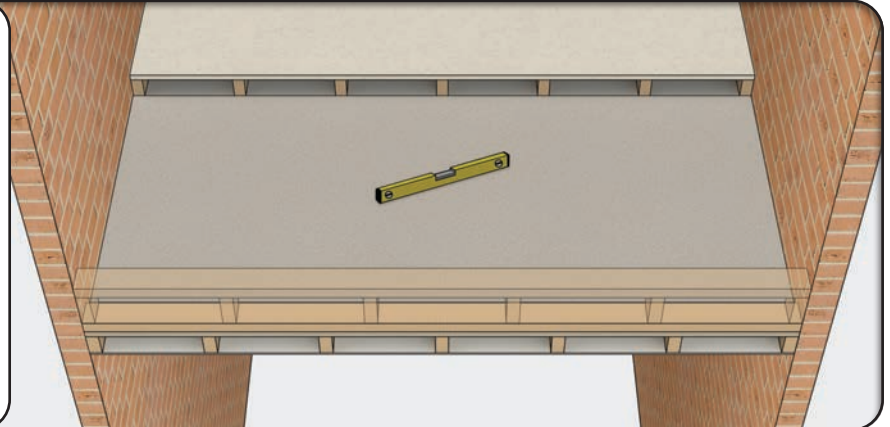

02.

Thoroughly clear the area of any debris to ensure a clean, dust free surface.

Ensure the balcony panels match the provided balcony layout diagram for the property before making a start.

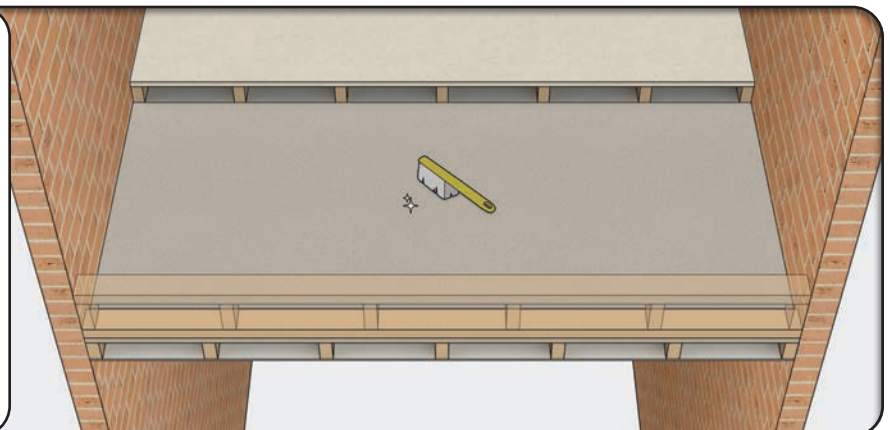

03.

PVC flashing is required around the perimeter of the balcony panels where stud framing is present.

Measure and cut appropriate length(s) of PVC flashing as required. Ensure all internal corners are formed as continuous corners.

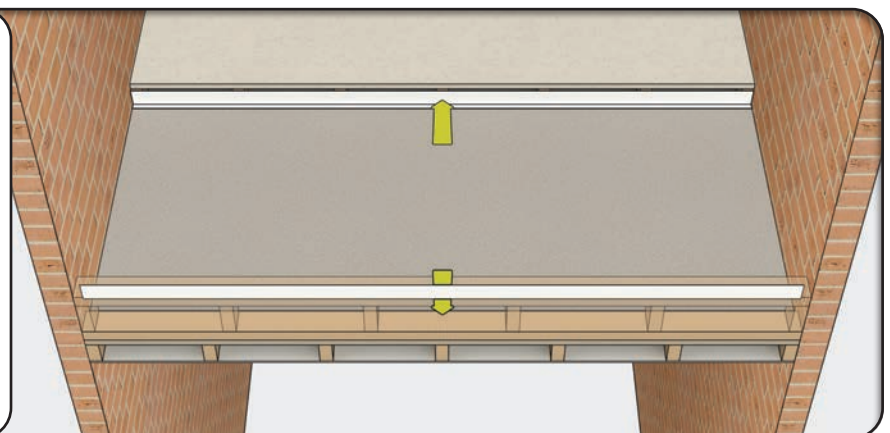

INSTALLATION STEPS

04.

Where necessary, create a continuous corner by cutting the base of the PVC flashing at the required length then make an adjoining cut at a 45° angle, discarding the triangular cut-out.

Fold the PVC flashing back and forth on itself repeatedly to create a vertical crease, indicated by the dotted line.

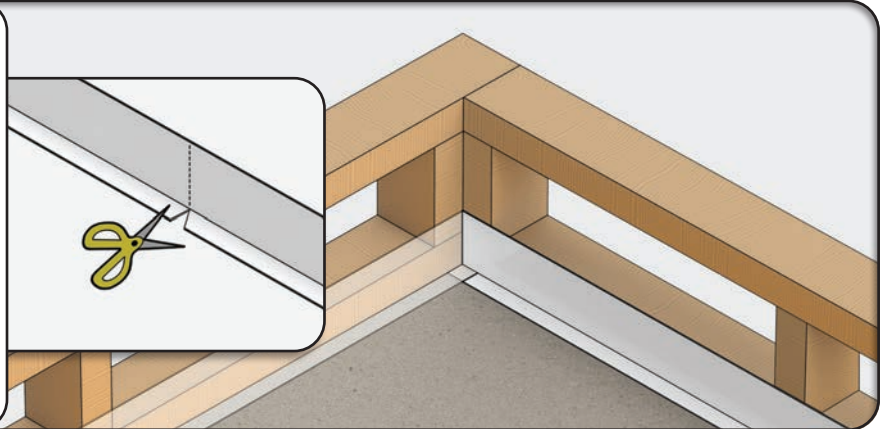

05.

Fold the PVC flashing in on itself to create a right angle and place in the corner of the balcony. Repeat as necessary for all remaining corners.

PVC flashing is never to be butted together to complete the balcony panel perimeter.

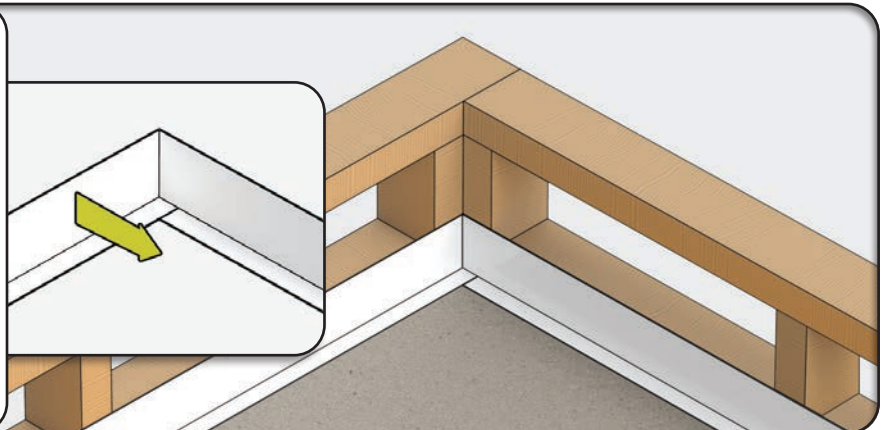

06.

If necessary, PVC flashing can be overlapped to complete the perimeter. Ensure any pieces overlap by at least **50mm** and the overlap occurs between two studs, as shown here.

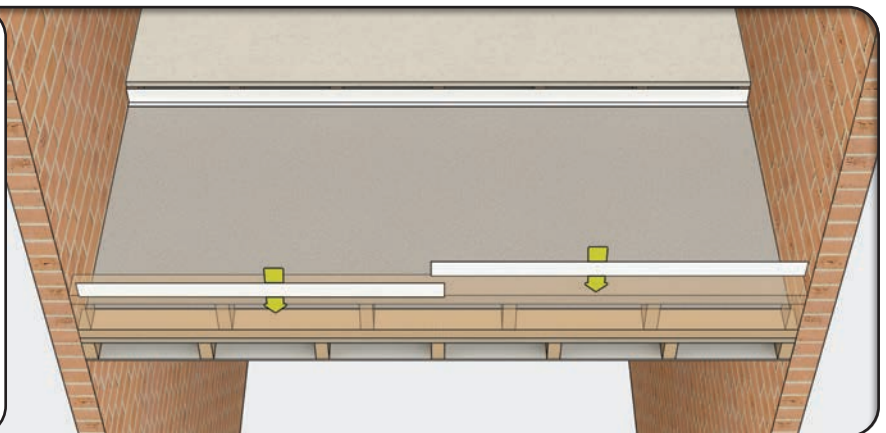

INSTALLATION STEPS

07.

Dry fit the balcony panels with the PVC flashing in place. Measure and mark the centre of the waste outlet on the substrate underneath.

Should any of the balcony panels require trimming, cutting or other adjustments, please do so at this stage.

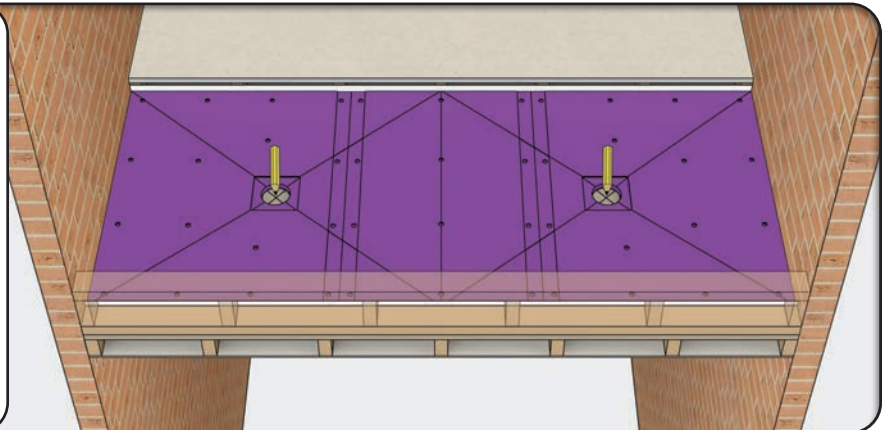

08.

Proceed to remove the balcony panels one by one, each time marking their position on the substrate underneath with a pencil or marker.

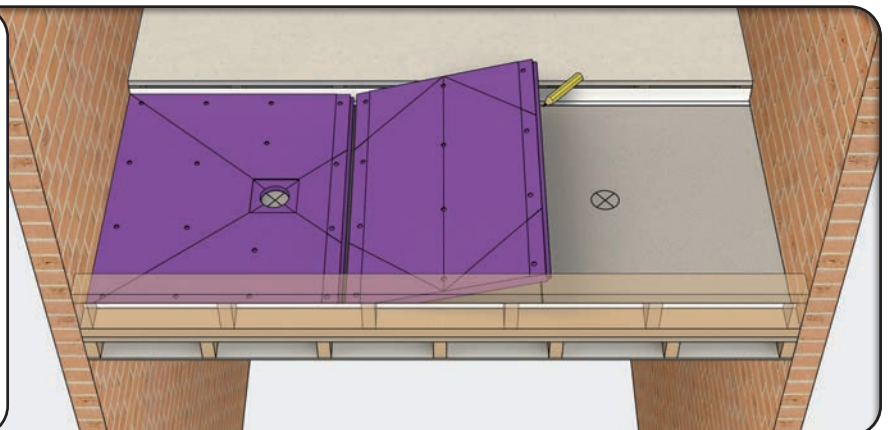

09.

The appropriate sleeve and grommet combination needs to be installed into the substrate.

Refer to the sleeve and grommet installation process on **Pgs. 13-14** for application specific directions.



INSTALLATION STEPS

10.

Remove everything from the area including the sleeve extension lid if applicable.

Proceed to install the PVC flashing using two continuous beads of CureflexTM HV124 silane, one underneath and the other behind where the PVC flashing will sit, as shown here.

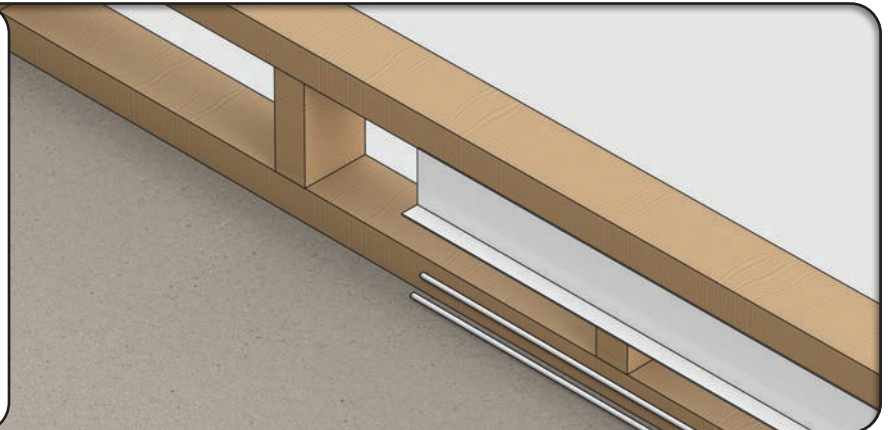

11.

Where overlaps occur, ensure two continuous beads of silane are applied vertically between the PVC flashing, as shown here.

Push the PVC flashing down firmly and smooth over any excess silane using a spatula tool before continuing.

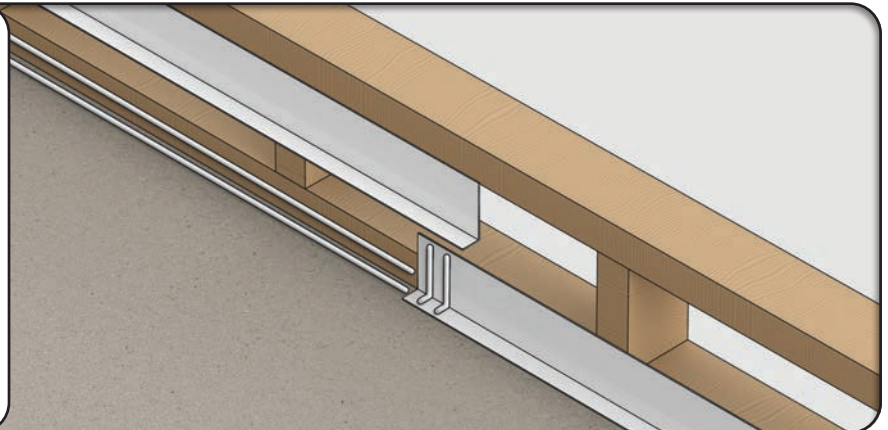

12.

If necessary, apply a continuous bead of silane along the perimeter of the balcony where the substrate meets brickwork, as shown here.

Smooth over any excess silane using a spatula tool. Ensure all voids in the substrate are filled with silane* sufficiently before continuing.



*PLEASE NOTE: Voids larger than 20mm must to be filled with structural material and sealed correctly prior to balcony panel installation.

INSTALLATION STEPS

13.

Remove the balcony panels and prime within the appropriate area. For porous substrates use Cureflex™ PG57 primer and for non-porous substrates use Cureflex™ LS151 primer. Please refer to manufacturer's recommendations.

Apply a minimum of 2 coats allowing 10 to 15 minutes between coats. The surface will become darker in colour and tacky to the touch when dry.



14.

Follow the Cureflex™ TX88 tile adhesive instructions to create a mixture with the desired consistency for the application.



15.

Use a 12mm notched trowel to spread the tile adhesive mixture evenly within the marked area of the first balcony panel to be installed.

Ensure a 20mm space is present between the perimeter of the marked area and the tile adhesive. This will prevent the adhesive from oozing out from under the balcony panel.



INSTALLATION STEPS

16.

Install the first balcony panel within the marked area on top of the tile adhesive.

Apply even pressure across the balcony panel to ensure the adhesive bonds well and provides maximum adhesion.

Ensure the waste outlet lines up correctly with the sleeve and grommet before moving on to the next balcony panel.



17.

All balcony panels must be correctly joined during installation. This process remains the same regardless of the type of join (tongue and groove or lap join).

In the case of a tongue and groove, apply a continuous bead of silane along the length of the tongue, as shown here.

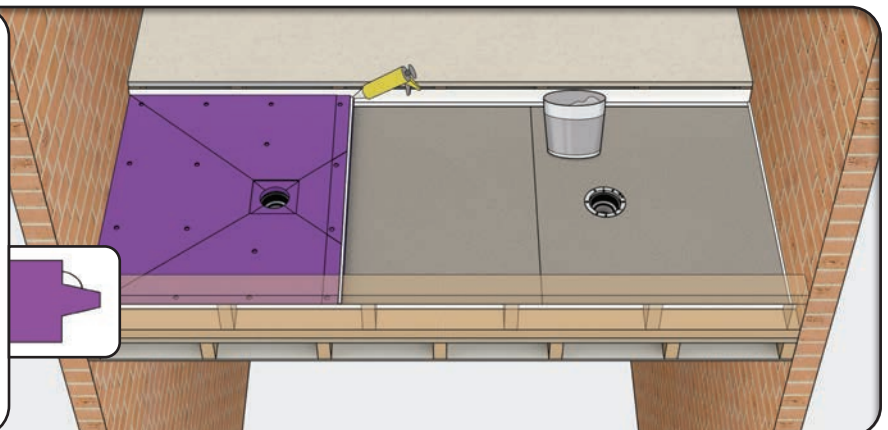

18.

Repeat **Step 15** within the marked area of the next balcony panel to be installed.

Subsequently, apply a continuous bead of silane along the length of the groove, as shown here.

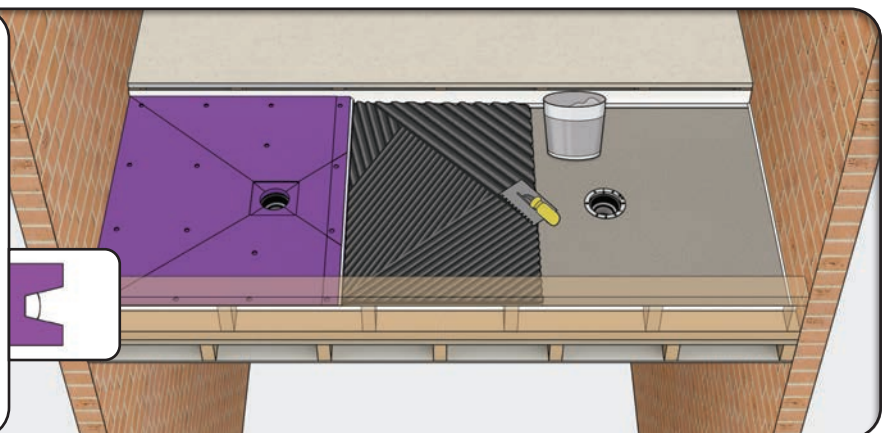

INSTALLATION STEPS

19.

Install the next balcony panel within the prepared area. Apply even pressure across the balcony panel and ensure they are both installed securely with the tongue pressed firmly into the groove.

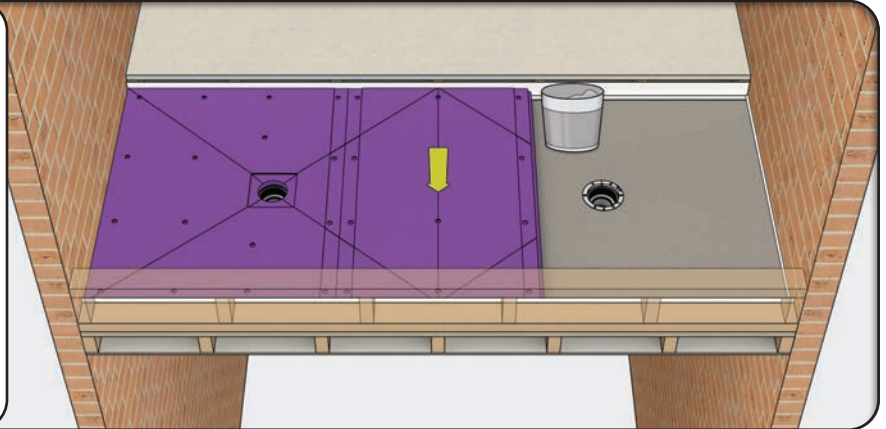

20.

Repeat **Step 15** within the marked area of the next balcony panel to be installed.

In the case of a lap joint, apply a continuous bead of silane along the length of the lower lap, as shown here.

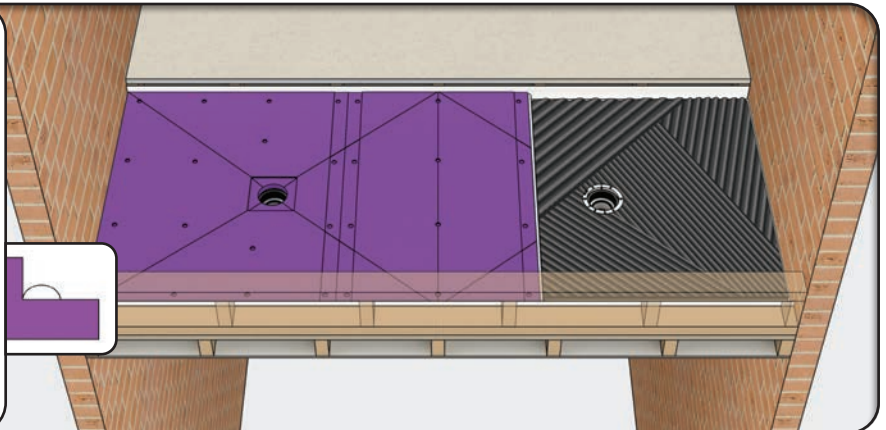

21.

Subsequently, apply a continuous bead of silane along the length of the upper lap, as shown here.

Repeat the process as necessary until all balcony panels have been installed. Please tailor this application for each balcony as the layout will change.

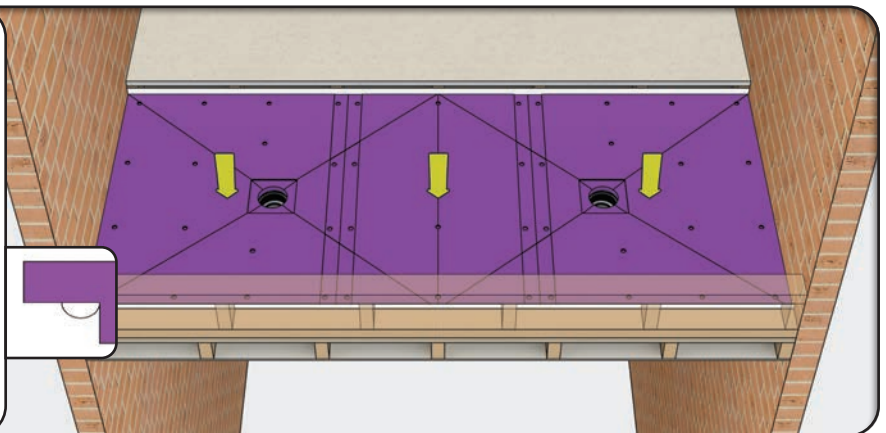

INSTALLATION STEPS

22.

Apply even pressure across the entire balcony to ensure the adhesive bonds well and provides maximum adhesion.

Check the level of the balcony panels in multiple areas and make any necessary adjustments before continuing. Ensure the fall ratio is not compromised and meets the required standard.

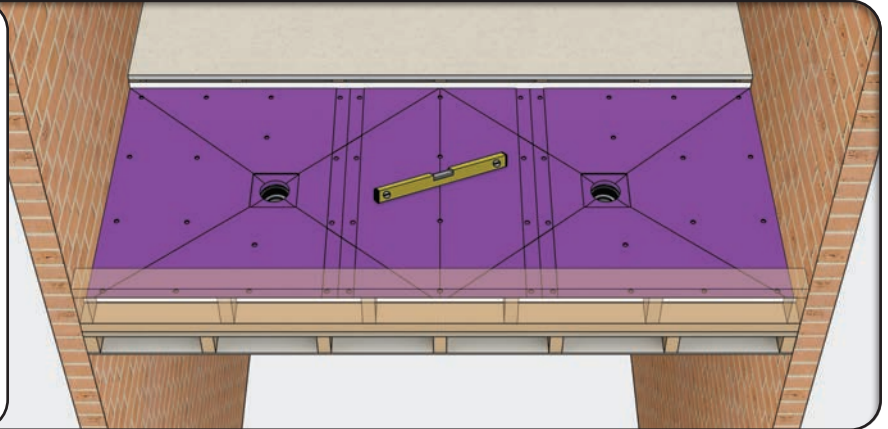

23.

Install the Leak Control Flange (LCF) into the preformed rebate in the balcony panels using two continuous beads of silane underneath where the LCF will sit, as shown here.

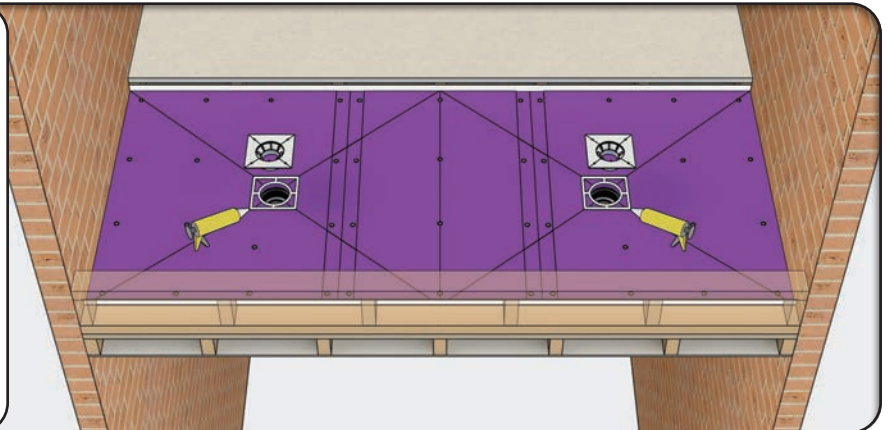

24.

In addition to the silane use **75mm** wood screws to secure the LCF. Smooth over any excess silane using a spatula tool, sealing the perimeter around the LCF.

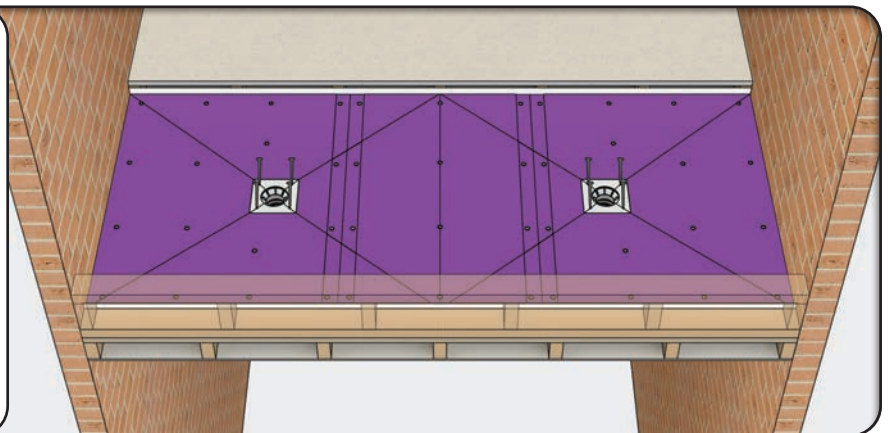

INSTALLATION STEPS

25.

Secure the balcony panels to the substrate using **75mm** hex drive screws. Each balcony panel will have a set of screw location rebates as a guide for where to fix the screws.

More screws may be required than indicated by the rebates and generally should be spaced **300mm** apart. Screw location and drive depth may be altered to maintain balcony panels fall ratio.



26.

Silane the entire internal perimeter of the balcony panels to the PVC flashing and surrounding wall structures/linings.

Additionally, silane all balcony panel joints and exposed screw heads. Smooth over any excess silane using a spatula tool.



27.

Place the protective matting over the balcony panels. Finally, pack up and clean the surrounding area.

The balcony panels are now ready for wall lining installation and subsequent waterproofing application.

Allows a minimum of **48 hours** before traffic to allow for sufficient curing of adhesive/sealant products.

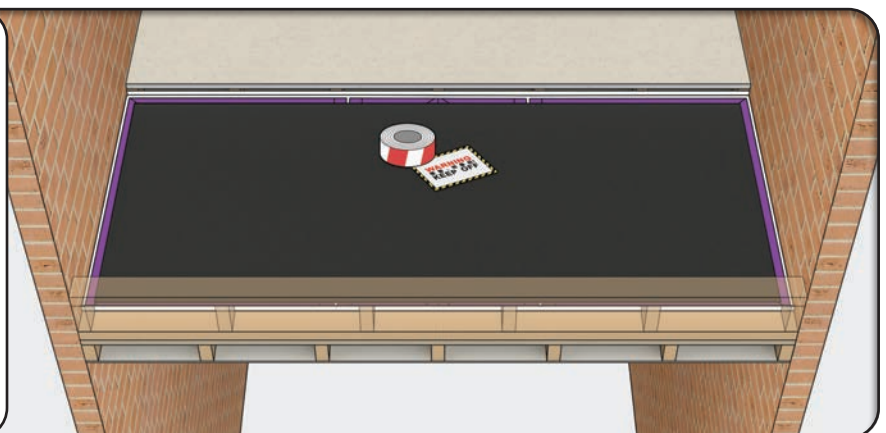

INSTALLATION STEPS

SLEEVE & GROMMET

01.

Measure and mark where the centre of the balcony panels waste outlet will sit on the substrate using a pencil or marker, if not already marked.

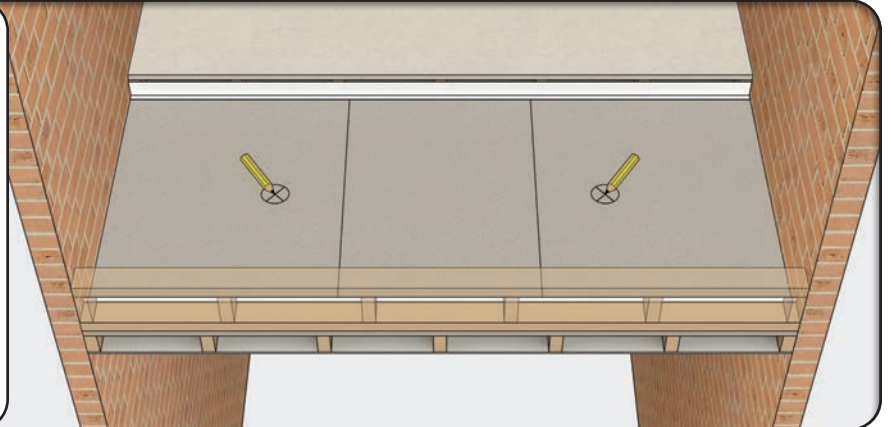

02.

Using a 133mm hole saw drill a hole where marked into the substrate.

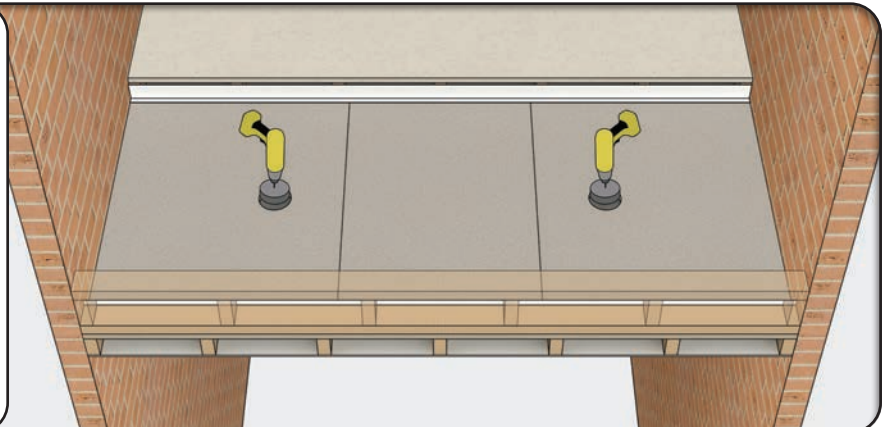

03.

Install a 100mm Sleeve Extension(s) into the substrate using one continuous bead of silane underneath, as shown here.

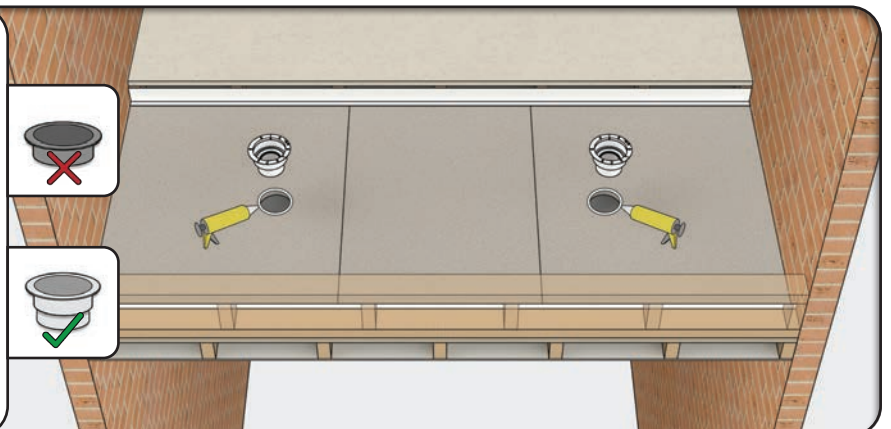

SLEEVE & GROMMET

04.

Secure the Sleeve Extension(s) to the substrate using **25mm** wood screws. Smooth over any excess silane using a spatula tool.



05.

Place a **100mm** Grommet(s) within the Sleeve Extension(s) and ensure the Grommet(s) remains within the Sleeve Extension(s) during the installation.



06.

The balcony is now ready to be connected to plumbing below.

The 100mm Sleeve Extension suits both 100mm and 90mm PVC pipe connections.

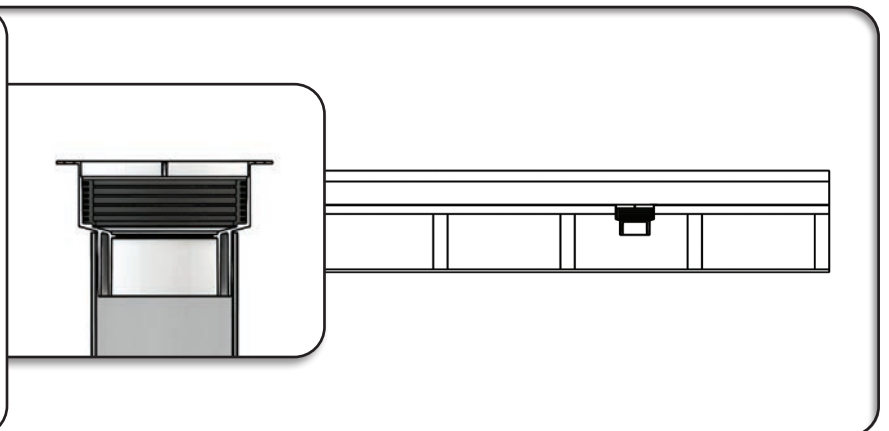

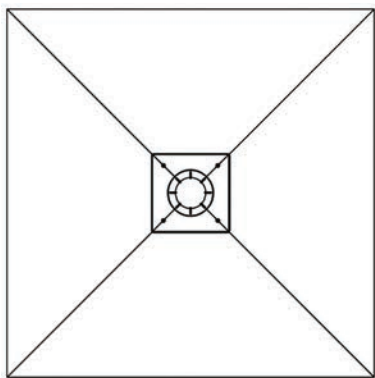
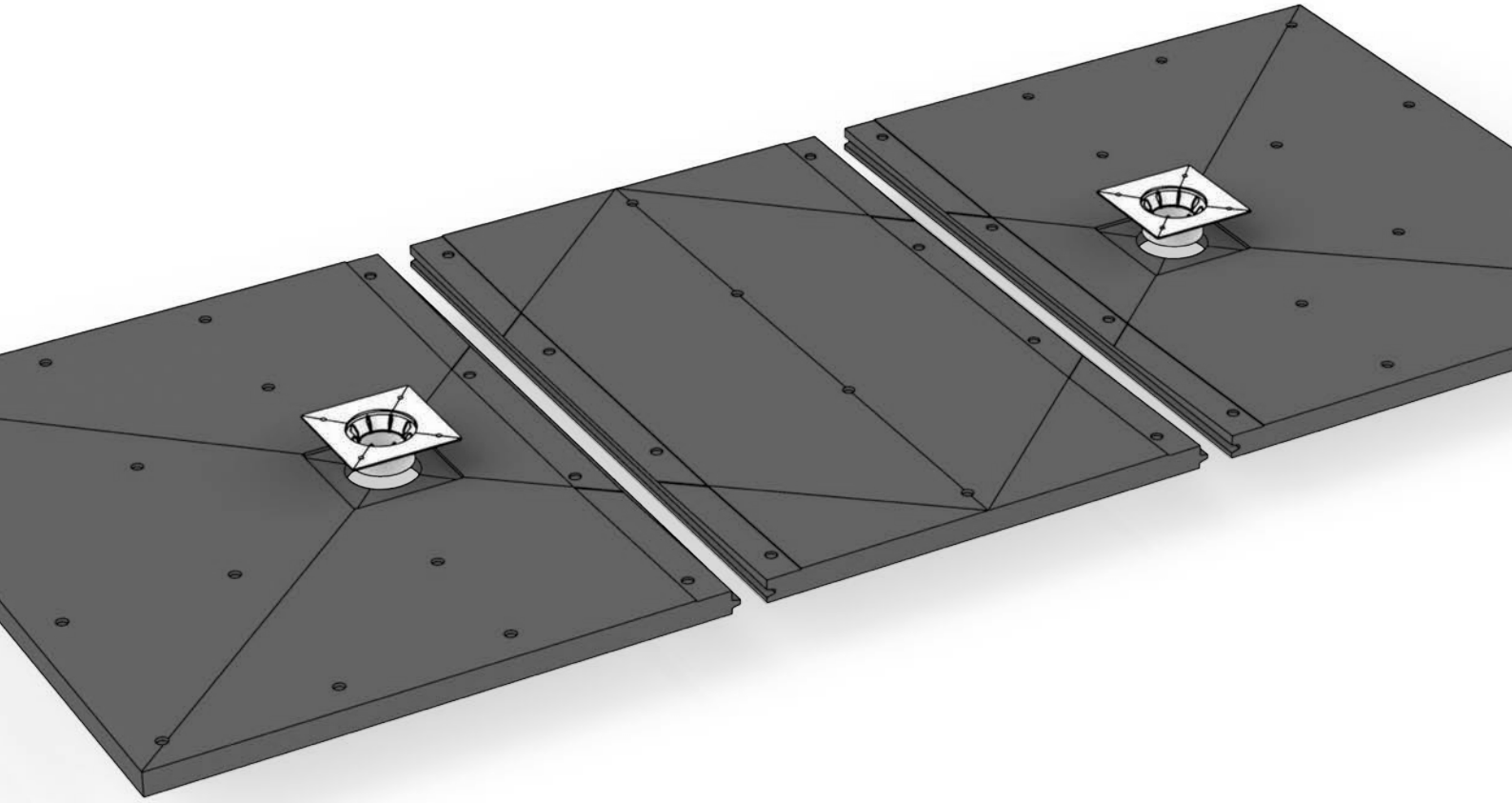

CENTRE WASTE BALCONY BASE

INSTALLATION GUIDE

